

Dehumidifier WDH-214US

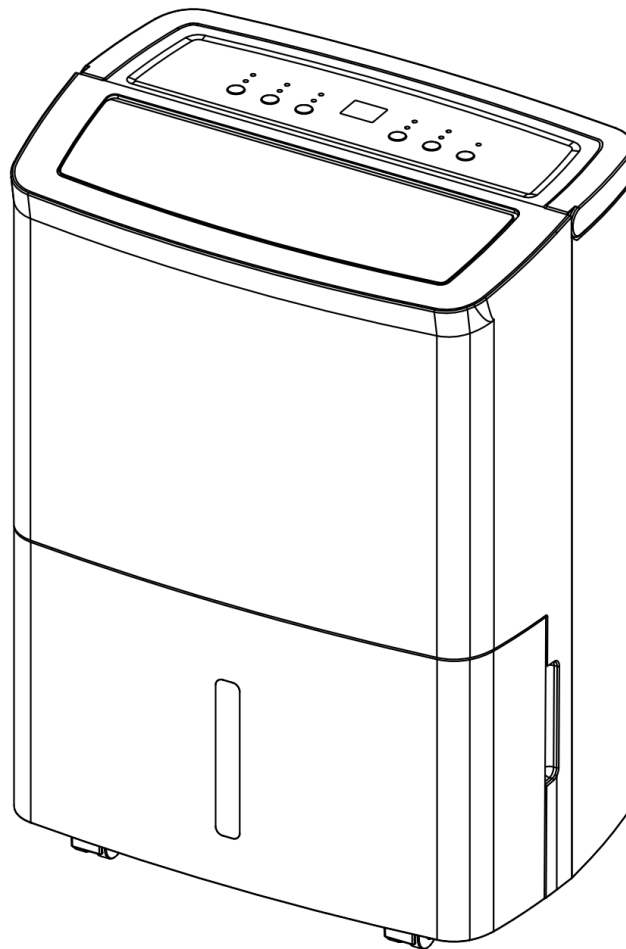

Dear customer,

you have chosen a high-quality product. Here are a few tips to help you enjoy this product:

After transportation:

As the appliance works with refrigerant, improper transportation can sometimes occur despite careful instructions on the packaging. We therefore ask you to leave the appliance upright for at least 4 hours to allow the refrigerant to settle properly in the appliance.

In case of any problems:

We hope that the appliance meets your expectations! Should there be any cause for complaint despite the greatest possible care, please contact us briefly, as we are very concerned about your satisfaction and would like to clear up any misunderstanding.

During the first operation:

Attention: Please check that the sealing plug (for using the collection container), which is located at the back of the appliance, is screwed on tightly! Otherwise, water may leak out from underneath your appliance.

As the inner pipes come into contact with moisture for the first time, it can take up to approx. 3 hours for liquid to collect in the collection container, depending on the room humidity.

Start-up time / delay:

To protect the compressor, it does not switch on again immediately after the appliance has stopped operating or there has been an interruption in operation (e.g. emptying the condensation tank). The compressor is initially in a so-called "protection mode" for approx. 3 minutes, in which only the fan runs before the compressor switches on again.

Room humidity and dehumidification performance:

If you would like to check the room humidity and the associated dehumidification performance with your own humidity meter (hygrometer), please ensure that this humidity meter is not attached to a wall, as this will falsify the true humidity content of the room air. See also the explanations under Troubleshooting!

Important safety instructions:

- Follow the operating instructions carefully when setting up, using and cleaning the appliance!
- Supervise the dehumidifier when children are near the appliance!
- Pay attention to the electricity, never go into the appliance with objects or insert them!
- Do not place any objects on the dehumidifier!
- Do not block the exhaust air fins of the appliance and please ensure that there is sufficient space/clearance around the fan!
- Ensure that there is sufficient air supply to the appliance, otherwise this can lead to a reduction in performance and, in the worst case, to overheating and/or fire!
- Make sure that no moisture reaches the electrical system of the appliance!
- Only use the recommended voltage for operating the appliance!
- Make sure that the power cable is unfolded (untied) before you connect it to the socket!
- Make sure that the plug is clean and properly connected to the socket before using the appliance!
- In the event of problems or damage, always contact the manufacturer immediately and never repair them yourself!
- Never touch the plug or socket with wet hands!
- Please do not use multiple sockets to operate the dehumidifier!
- Do not repair defective or damaged cables on the appliance yourself, you could get a serious electric shock!
- Ensure that flammable substances (e.g. gases/oils etc.) are never in the vicinity of the appliance!
- The appliance is intended for indoor use only. It should also not be used in a laundry room!
- If you are not going to use the appliance for a longer period of time, switch it off and unplug it from the mains!
- The appliance must be stored in a well-ventilated room in which the room size corresponds to the room area specified for operation.
- This appliance can be used by children aged from 8 years and above if they have been given supervision or instruction concerning use of the appliance in a safe way and understand the hazards involved. Cleaning and user maintenance must not be carried out by children unless they are 8 years and older and are supervised. The appliance and its connecting cable must be kept away from children under the age of 8.
- Do not make any changes to the device!
- The dehumidifier should not be operated or stored in a room with other burning/heating appliances!

Please switch off the appliance immediately and disconnect it from the mains/power supply if anything appears to be wrong! In this case, please contact a specialist and do not attempt to repair the appliance yourself!

Examples: Fan does not run during operation, fuse has blown or the compressor rattles loudly.

Important operating and safety instructions regarding the refrigerant R290 in this appliance:
(Read these instructions carefully and observe them before using the device!)

- R290 refrigerant gas complies with European environmental regulations.
- The appliance works with the refrigerant R290. This refrigerant is highly flammable and explosive if the safety instructions are not observed!
- The appliance contains 0.065 kg of R290 refrigerant - the maximum permitted filling quantity of R290 refrigerant for dehumidifiers is 0.3 kg!
- The minimum air circulation at low speed is 98 m³/h, at high speed 115 m³/h!
- The appliance must be stored in a room without continuously operating ignition sources (e.g., open flames, an operating gas appliance or an operating electric heater).
- Protect the appliance and especially the internal parts from damage or flames/heat!
- Please note that the refrigerant is odorless and a leak cannot be detected immediately by the smell!
- If refrigerant should escape, it can ignite or explode, particularly in poorly ventilated rooms in conjunction with high heat, sparks or flames!
- Make sure that the exhaust air outlet is always ensured and is not obstructed by other objects!
- The appliance should be set up, operated and stored in a room with a minimum size of 4 m² !
- Pack the device carefully when you are no longer using it and protect it from damage! Be careful when storing the device to avoid mechanical faults.
- When cleaning, proceed strictly according to the manufacturer's instructions and do not use any additional heat sources to accelerate the defrosting process of the appliance!
- Never work on the cooling circuit or parts containing refrigerant yourself!
- Only persons who are authorized and certified by an accredited agency for handling refrigerants should work on the refrigerant circuit.
- If the mains connection cable of this appliance is damaged, it must be replaced by the manufacturer or its customer service department or a similarly qualified person in order to avoid hazards.
- The appliance must be installed in accordance with national installation regulations.
- Do not use any objects other than those permitted by the manufacturer to accelerate the defrosting process.
- Do not drill or burn.

This appliance has parts that must not be replaced or repaired !

The refrigerant cannot be renewed or replaced !

Do not carry out any repairs or modifications to your device yourself !

Maintenance and repair work requiring the assistance of other qualified persons must be carried out under the supervision of specialists in the use of flammable refrigerants.

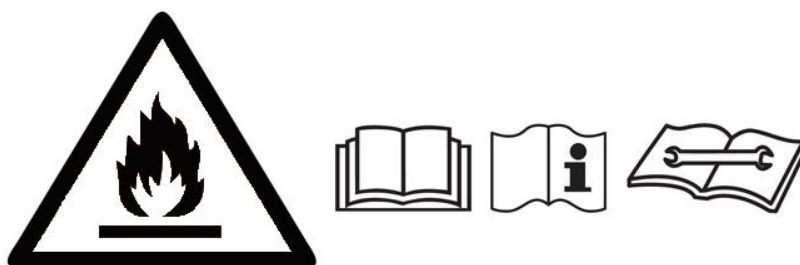

Important safety instructions for repairing an appliance with R290 refrigerant:

1. Check the surroundings

Before you start working on systems that contain flammable refrigerants, safety checks are required to ensure that the risk of ignition is minimized. When repairing the refrigerant system, the following safety precautions must be observed and complied with before any work is carried out on the system.

Procedure

The work must be carried out in a controlled manner to minimize the risk of flammable gases or vapors being present during the execution of the work.

2. General work area

All maintenance personnel and other persons in the vicinity must be instructed on the type of work to be carried out. Work in confined spaces must be avoided. The area around the work area must be cordoned off. Ensure that the conditions in the work area have been made safe by checking the flammable material.

3. Check for the presence of refrigerants

The area must be checked with a suitable refrigerant detector before and during the work to ensure that the technician is aware of possible flammable atmospheres. Ensure that the refrigerant detector used is suitable for working with flammable refrigerants, e.g. non-sparking, adequately sealed and intrinsically safe.

4. Presence of a fire extinguisher

If hot work is to be carried out on the refrigerant equipment or associated parts, suitable fire extinguishing equipment must be readily available. Ensure that a dry powder fire extinguisher or a CO₂ fire extinguisher is nearby.

5. No ignition sources

Persons carrying out work in connection with a refrigerant system which involves exposure to pipework containing or having contained flammable refrigerants must use ignition sources in such a way that they cannot cause a fire or explosion hazard. All possible ignition sources, including cigarette smoking, should be kept sufficiently away from the site of installation, repair and disposal during which the flammable refrigerant may be released into the surrounding area. Prior to work, the area around the equipment must be inspected to ensure that there are no flammable hazards or ignition risks. "No Smoking" signs must be posted.

6. Ventilated area

Ensure that the work area is outdoors or that it is sufficiently ventilated before interfering with the system or carrying out hot work. Sufficient ventilation must be ensured for the entire duration of the work to be carried out. The ventilation should safely disperse any refrigerant released and preferably discharge it externally into the atmosphere.

7. Testing the refrigerant equipment

If electrical components are replaced, they must be suitable for the purpose and have the correct specification. The manufacturer's guidelines for maintenance and repair must be observed and followed at all times. If in doubt, contact the manufacturer's technical department for assistance. The following tests must be applied to installations containing flammable refrigerants:

- The filling quantity is in accordance with the room size within which the parts containing refrigerant are installed;
- The ventilation equipment and the ventilation outlets are running properly and are not blocked.

8. Testing of electrical devices

Before repairing and maintaining electrical components, preliminary safety checks and inspections must be carried out on the components. If there is a defect that could jeopardize safety, the appliance must not be connected to the mains until the defect has been rectified. If the defect cannot be repaired immediately but operation must continue, an adequate temporary solution must be found. This must be reported to the owner of the equipment so that all parties are informed.

The preliminary safety checks must include

Capacitors must be discharged; this should be done in a safe manner to avoid the possibility of sparking.

No live components and wiring must be exposed when filling, restoring or flushing the system. Continuity of the earth connection.

9. Repairs to hermetically sealed components

During repair of hermetically sealed components, all power to the appliance must be disconnected before removing sealed covers etc. If it is essential that power is supplied to the appliance during maintenance, a permanent leak detection system must be in place to warn of a potentially dangerous situation.

Particular attention must be paid to the following point to ensure that when working on electrical components, the enclosure is not modified in such a way that the degree of protection is impaired. This includes damage to cables, an excessive number of connections, terminals that do not comply with the original specification, damage to seals, improper fitting of sealing screws, etc.

Make sure that the appliance is securely mounted.

Ensure that seals or sealing material are not so worn that they no longer serve their purpose to prevent the ingress of flammable atmospheres. Replacement parts must be in accordance with the manufacturer's specifications.

NOTE: The use of silicone sealants may hinder the effectiveness of some leak detectors.

Intrinsically safe components do not need to be sealed before working on them.

10. Repair of intrinsically safe components

Do not apply a permanent inductive load or capacitive load to the circuit without ensuring that this does not exceed the permissible voltage and current for the equipment being used. Intrinsically safe components are the only types that can be worked on while connected to the mains in the presence of a flammable atmosphere. The test equipment must have the correct ratings. Replace components only with parts specified by the manufacturer. Other parts may cause the refrigerant to ignite in the atmosphere due to a leak.

11. Cabling

Check that the cabling is not subject to wear, corrosion, excessive pressure, vibrations, sharp edges or other harmful environmental effects. The test must also take into account the effects of ageing or continuous vibration from sources such as compressors or fans.

12. Detection of flammable refrigerants

Under no circumstances should potential ignition sources be used when searching for or detecting refrigerant leaks. A halogen searchlight (or any other search device that uses naked flames) must not be used.

13. Leak detection methods

The following leak detection methods are considered acceptable for systems containing flammable refrigerants.

Electronic leak detectors must be used to detect flammable refrigerants, but their sensitivity may not be sufficient or they may need to be recalibrated. (Detection equipment must be calibrated in a refrigerant-free area.) Ensure that the leak detector is not a potential ignition source and that it is suitable for the refrigerant used. Leak detection equipment must be set to a percentage of the lower explosion limit and must be calibrated to the refrigerant used and the adequate percentage of the gas (25% maximum) must be confirmed.

Leak detection fluids are suitable for use with most refrigerants, but the use of cleaning agents containing chlorine must be avoided as chlorine can react with the refrigerant and degrade the copper piping.

If a leak is suspected, remove/extinguish all naked flames.

If a refrigerant leak is detected that requires brazing, all refrigerant must be recovered from the cooling system or isolated (by shutting off valves) in a part of the system remote from the leak. Oxygen-free nitrogen must then be flushed through the system before and during the brazing process.

14. Removal and emptying

If you are intervening in the refrigerant circuit to carry out repairs - or for any other reason - conventional methods must be used. However, it is important that best practice is always followed, as flammability must be taken into account. The following procedure should be followed:

- Remove the refrigerant
- Flush the circuit with inert gas
- Deflate
- Flush again with inert gas
- Open the circuit by cutting or soldering

The refrigerant charge must be prepared in the correct preparation cylinders. The system must be "purged" with oxygen-free nitrogen to keep the appliance safe. This process may need to be repeated several times. Compressed air or oxygen must not be used for this purpose.

Purging can be achieved by intervening in the vacuum in the system with oxygen-free nitrogen and continuing to charge until the working pressure is reached and then releasing to atmosphere and finally drawing into a vacuum. This process must be repeated until there is no more refrigerant in the system. When the last filling with oxygen-free nitrogen takes place, the system must be vented to atmospheric pressure. This is absolutely necessary if soldering work has to be carried out on the pipework. Make sure that the outlet for the vacuum pump is not located near sources of ignition and that ventilation is available.

15. Filling process

In addition to conventional filling processes, the following requirements must be followed:

- Ensure that no contamination of the various refrigerants occurs when filling the equipment. Hoses or cables must be as short as possible to minimize the amount of refrigerant they contain.
- Cylinders must remain upright.
- Ensure that the cooling system is earthed before filling the system with refrigerant.
- Mark the system when filling is complete (if not already done).
- Extreme care must be taken not to overfill the cooling system.
- Before refilling the system, the pressure must be tested with oxygen-free nitrogen. The system must be tested for leaks at the end of filling but before commissioning. A check leakage test must be carried out before leaving the site.

16. Decommissioning

Before carrying out this procedure, it is necessary that the technician is fully familiar with the equipment and its details. It is a recommended standard that all refrigerants are safely reconditioned. An oil and refrigerant sample must be taken prior to the task to be carried out in case analysis is required before the reclaimed refrigerant is reused. It is necessary that electrical power is available before the task is started.

- a) Familiarize yourself with the equipment and its operation.
- b) Disconnect the system electrically.
- c) Make sure before you carry out the procedure;
 - that mechanical handling equipment is available, if necessary, also for handling refrigerant cylinders;
 - that personal protective equipment is available and worn properly;
 - that the reprocessing process is supervised by a competent person at all times;
 - that the reprocessing equipment and cylinders comply with the applicable standards.
- d) Pump out the refrigerant system if possible.
- e) If a vacuum is not possible, create a manifold so that the coolant can be removed from the various parts of the system.
- f) Make sure that the cylinder is on the scales.
- g) Start the treatment system and operate it according to the manufacturer's instructions.
- h) Do not overfill the cylinders (no more than 80 % liquid filling capacity)
- i) Do not exceed the maximum working pressure of the cylinder, not even temporarily.
- j) When the cylinders have been properly filled and the process is complete, ensure that the cylinders and equipment are immediately removed from site and that all shut-off valves on the equipment are closed.
- k) Recycled refrigerant must not be filled into other cooling systems unless it has been cleaned and tested.

17. Labeling

The equipment must be labeled to indicate that it has been decommissioned and that the refrigerant has been drained. The marking must be dated and signed. Ensure that there are markings on the equipment stating that the equipment contains flammable refrigerant.

18. Reprocessing

When removing refrigerant from a system, either for maintenance or decommissioning, it is recommended as standard that all refrigerant is safely removed. When transferring refrigerant to cylinders, ensure that only suitable refrigerant recovery cylinders are used. Ensure that the correct number of cylinders are available to hold the total amount of refrigerant. All cylinders used must be suitable and marked for the reconditioned refrigerant (i.e. special cylinders for reconditioning refrigerant). The cylinders must have a pressure relief valve and a connected shut-off valve and be in good working condition. Empty reprocessing cylinders must be emptied of air and, if possible, cooled before reprocessing.

The reprocessing plant must be in good working order with appropriate instructions concerning the equipment and must be suitable for the reprocessing of flammable refrigerants. In addition, a set of calibrated scales in good working order must be available. Hoses must be complete with leak-free and proper disconnect couplings. Before using the reconditioner, check that it is in good working order, that it has been properly maintained and that all associated electrical components are sealed to prevent ignition in the event of a refrigerant leak. If in doubt, contact the manufacturer.

The reconditioned refrigerant must be returned to the refrigerant supplier in the correct reconditioning cylinder and the appropriate disposal certificate must be arranged. Do not mix refrigerant in remanufacturing units and especially not in cylinders.

If a compressor or compressor oils are to be removed, ensure that they have been evacuated to an acceptable level to ensure that no flammable refrigerant remains in the lubricant. The evacuation process must be carried out before returning the compressor to the supplier. Only electrical heating of the compressor housing may be used to accelerate this process. When draining oil from a system, this must be done in a safe manner.

19. Electrical components

Electrical components that can generate arcs or sparks and that are not considered ignition sources due to compliance with 22.116.1 letters b), c), d) or f) may only be replaced by parts specified by the appliance manufacturer. Replacement with other parts may lead to ignition of the refrigerant in the event of a leak.

Warnings:

Do not kink/bend the cable!



Make sure that the plug is fully and firmly inserted into the socket!

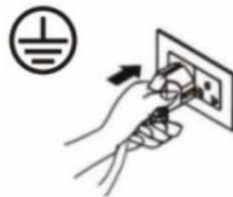

Do not use multiple sockets, adapters and extension cables!

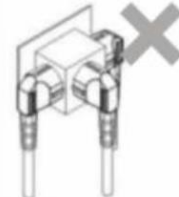

Make sure that the plug is clean!

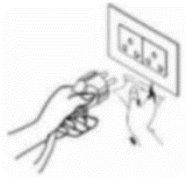

If you are no longer using the appliance, please unplug it from the socket!

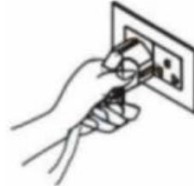

Never operate the mains plug with wet hands!



Precautionary measures:

Please no objects on the control panel!

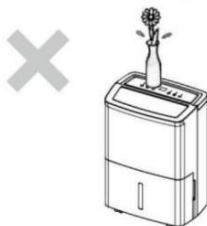

Do not place any objects over the outlet opening!



Keep children away from the appliance!



Protect the device from moisture!



Protect the device from solvents, irritants and flammable substances!

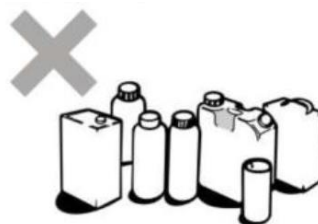

Have maintenance carried out by specialists only!



Description of the device parts:

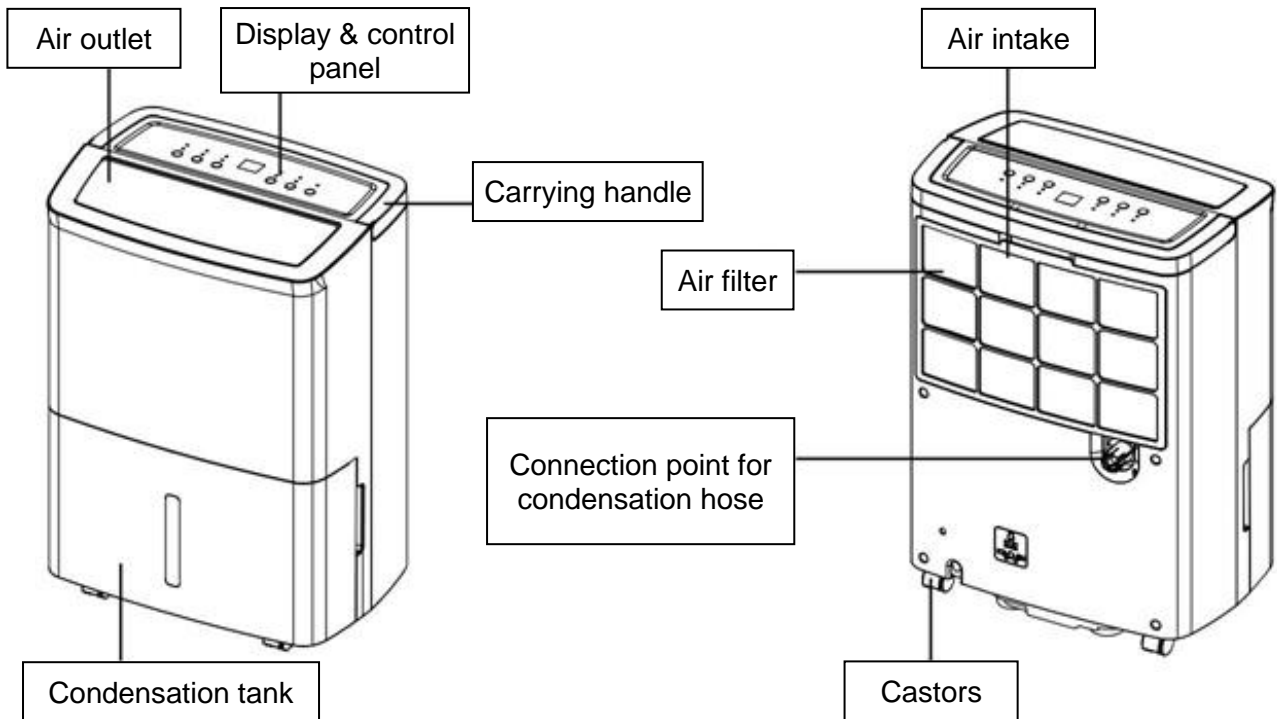

Functional description:

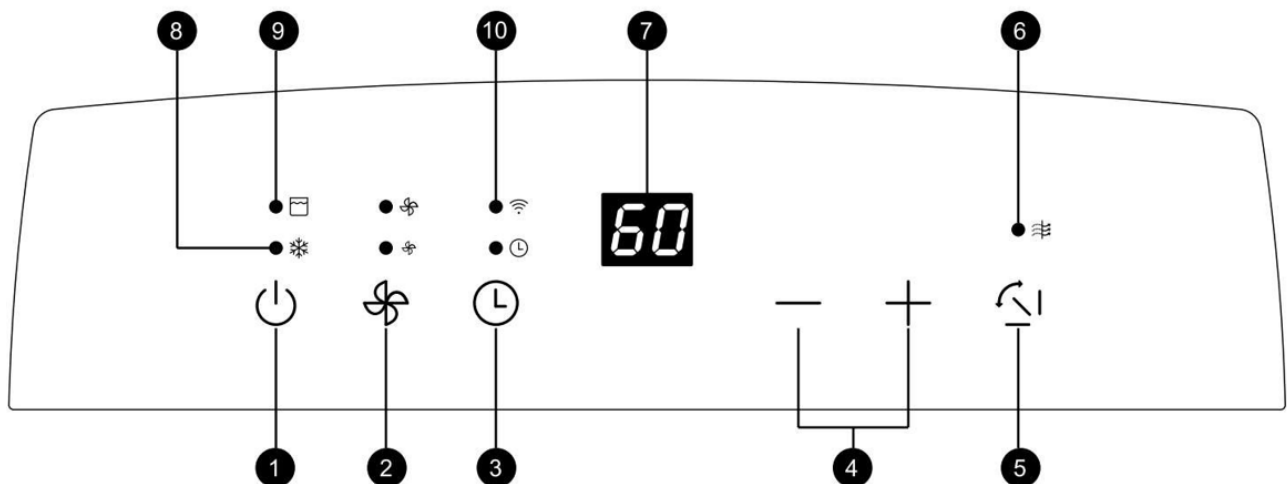

- | | |
|------------------------------------|---|
| 1.) Operating switch (On / Off) | 6) Filter cleaning lamp |
| 2.) Fan speed button (Low / High) | 7) Display |
| 3.) Timer button (from 1-24 hours) | 8) Defrost lamp (appliance in defrost mode) |
| 4.) Humidity setting buttons | 9) "Condensation tank full" signal light |
| 5.) Swing button (for the slats) | 10) WiFi function |

The WiFi function

The appliance can also be conveniently controlled remotely via an app. To do this, use the "**SmartLife**" or the "**Tuya Smart**" app from the [Apple App Store](#) or the [Google PlayStore](#). To set it up, follow the instructions in the app. The WI-FI indicator light shows the current status of the device. The light will cycle through phases 1-5 during a new setting. Once the device has been successfully connected, it can be controlled via the app. All device functions are available in the app.

There are two ways to disconnect the connection between the device and the connected router:

- Remove the device via the **SmartLife app**.
- Press the POWER button for at least 5 seconds.

Description	LED
Coupling configuration	Fast flashing (250 ms)
Coupling with the app	Fast flashing (1500 ms)
Pairing successful, but no connection to the router	Off
Pairing successful and a connection to the router successful	On
Successful connection to the app	On
WI-FI in stand-by mode	Off

Please note: If the dehumidifier is operated for a longer period of time (more than 24 hours continuously), the dehumidifier is switched on for 24 hours and then switched off for one hour. During the switch-off phase, the appliance can still be adjusted, but the fan speed lights will flash for 3 seconds. The appliance switches on again automatically after the hour has elapsed.

Defrost button

If the appliance is operated at low temperatures (below 12°C), frost forms on the surface of the evaporator and impairs the efficiency of the dehumidifier. When this happens, the appliance automatically switches to periodic defrost mode. This is quite normal. The defrost lamp lights up. The appliance works at temperatures down to 5°C. The defrosting time may vary. If the dehumidifier freezes, switch the appliance off for a few hours and then restart it. It is not recommended to use the dehumidifier at temperatures below 5°C.

Continuous outflow:

Continuous water drainage can be carried out in a suitable environment using the following steps:

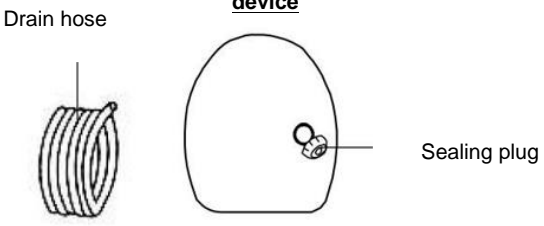
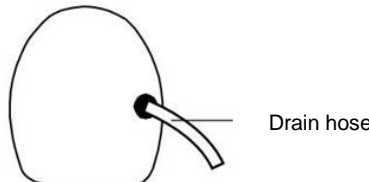
<ol style="list-style-type: none"> 1. Prepare the hose for draining the water (the commercially available hose has an internal diameter of 13 mm). 2. Remove the drain plug. 	<p style="text-align: center;"><u>Back of the device</u></p>  <p>Drain hose</p> <p>Sealing plug</p>
<ol style="list-style-type: none"> 3. Connect the hose to the drain outlet. 	 <p>Drain hose</p>

The right way to place the water drain hose:

For continuous drainage, the hose must be attached below the drainage hole. Avoid uneven surfaces and do not kink the hose.

Instructions for use:

1 Commissioning

1.1. Insert the plug into a suitable socket. The dehumidifier is suitable for operation on a power supply with the same voltage as specified on the rating plate.

1.2. Make sure that the water tank is positioned correctly. (If the "condensation tank full" light comes on after the appliance is switched on for the first time, simply pull out the water tank, check that the "float" can move freely and put the water tank back in the correct position.

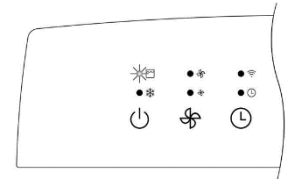

1.3. If the appliance is operated at low temperatures (below 12°C), frost forms on the surface of the evaporator and impairs the efficiency of the dehumidifier. When this happens, the appliance automatically switches to periodic defrost mode. This is quite normal. The defrost lamp lights up. The appliance works at temperatures down to 5°C. The defrosting time may vary. If the dehumidifier freezes, switch the appliance off for a few hours and then restart it. It is not recommended to use the dehumidifier at temperatures below 5°C.

1.4. Switch on the appliance with the operating switch. Now press the humidity setting buttons using the +/- buttons and set the desired target humidity. The humidity can be set in 5% increments within a range of 30% - 90% humidity. The target value of 30% humidity corresponds to continuous operation!

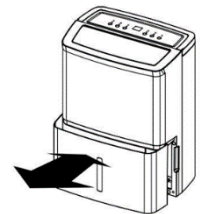

Note: The value you set must be below the current room humidity for the appliance to dehumidify. If your set value is above the current room humidity, the fan runs for 3 minutes and the appliance then switches off. If the room humidity rises above the set value, the appliance automatically starts the dehumidification mode again.

1.5. Use the fan speed button  to select between a low and a high fan speed or air circulation.

1.6. If you want to activate/use the timer function (function for determining the remaining running time or function for specifying a start time), press the TIMER button.

Determining the remaining running time: Press the TIMER button during operation to select the desired remaining running time of the dehumidifier. (A value between 1 - 24 hours can be selected using the humidity setting buttons). After this selected operating time has elapsed, the appliance switches off automatically.

Determining a start time: When the dehumidifier is switched off, press the TIMER button to select the desired start time. (A value between 1 - 24 hours can be selected using the humidity setting buttons). After this selected time has elapsed, the appliance switches on automatically (with the last settings used, provided the mains plug has not been disconnected in the meantime).

1.7. First download the "Tuya Smart" app (alternatively the "SmartLife" app) on your smartphone (tablet) from the app store. After downloading the app, open it and make sure that your smartphone is connected to your Wi-Fi network and that the Bluetooth function on your smartphone is switched on. Now follow the instructions in the app to register. After registering, click on "Add device" in the app. Select the "Dehumidifier" button under the "Small household appliance" category. The dehumidifier should now be displayed. Click on it to connect it to your smartphone via the app. As soon as your smartphone is paired with the dehumidifier, the signal light of the WLAN function in the display stops flashing and lights up continuously.

Now you can conveniently set the dehumidifier via the app and at the same time read off values such as the current room humidity without having to stand directly in front of the appliance.

Note: If you do not use the WLAN function for a longer period of time or do not connect the dehumidifier to a WLAN network, this function switches to standby mode and the signal light stops flashing. To reactivate the WLAN function, you must switch off the appliance and then press and hold the On/Off button for 5 seconds until a sound confirms activation. The device should now be switched on and the signal light should flash again. The WLAN function is active again.

- 1.9. When the condensation tank is full, the signal light lights up and the dehumidifier automatically stops dehumidifying. Remove the condensation tank and empty it. After you have pushed the condensation tank properly back into the appliance, dehumidification operation will start again automatically.

Please use both hands to carefully empty the water tank!

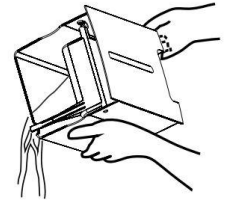

2. Connecting a hose

- 2.1. You will need a 1/2-inch plastic hose.
2.2. The hose connection is closed by a cover. Unscrew this cover and remove the screw cap and the black rubber plug on the inside (see illustration "Description of the appliance parts" above).
2.3. Now guide the plastic hose onto the black drip tap provided. Push the hose as far as possible onto the drip tap and make sure that the hose is firmly attached and cannot come loose.
2.4. Correct drainage of condensation water with hose connection! Make sure that the hose always has a slight gradient (see the following diagrams).

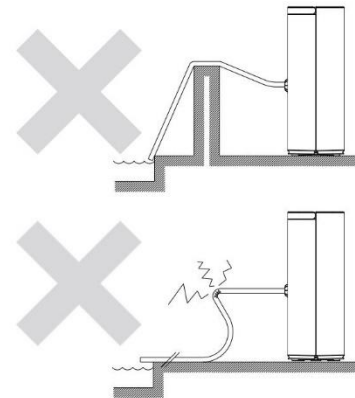
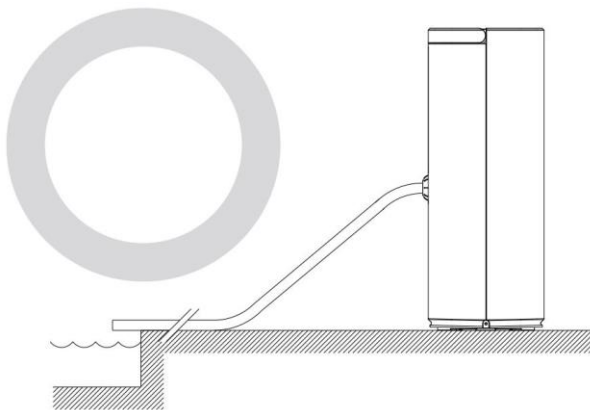

3. Other operating instructions

- 3.1. Do not disconnect the mains plug by pulling on the power cable!
3.2. Do not use insect repellent, oil or paint spray etc. near the dehumidifier. This can damage the appliance or even cause a fire!
3.3. Do not place the appliance on a sloping or uneven surface!
3.4. Please always keep a distance of approx. 20 cm from the wall to prevent the appliance from overheating. Please also ensure a distance of approx. 50 cm from the top when drying laundry!
3.5. For effective and economical dehumidification operation, please close all doors and windows in the dehumidifier room!
3.6. Please keep the appliance away from heat sources!
3.7. Always keep the device in its proper and upright position and transport it!
3.8. Remove any residual water from the condensation tank before moving the appliance.

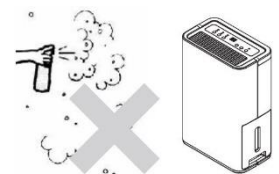
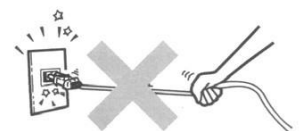

4. Cleaning

For safety reasons, make sure that the dehumidifier is disconnected from the power supply before servicing or cleaning the appliance!

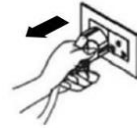

4.1. Cleaning the housing

- a) Wipe the housing with a soft, clean cloth.
- b) If the dehumidifier is very dirty, please use a mild cleaning agent and wipe off the cleaning agent with a half-dried cloth.
- c) Do not wash the appliance with a hose, otherwise electricity may escape.

4.2. Cleaning the air filter

The air filter filters lint, hair and coarse dust. The air filter is coated with an antibacterial glaze to inhibit the growth of bacteria. The air filter also ensures that less dust is deposited on the cooling fins, thus guaranteeing greater efficiency. Always clean the filter if it can be assumed that the air intake is reduced by the dirty air filter!

4.3. Steps for cleaning:

- a) Release the filter by pulling it out of its holder.



- b) It is best to clean the air filter carefully under lukewarm water or with a vacuum cleaner on a low setting (suction power).

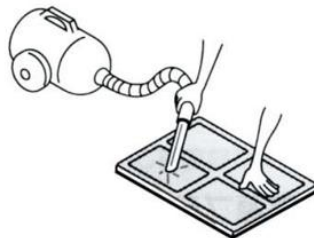

- c) Push the filter back into its original position.

Technical data:

Model designation:	WDH-214US
Voltage:	220-240 V / 50Hz
Maximum power consumption:	195 W
Dehumidification capacity (optimum):	16 liters/day (32°C / 90% r.h.)
Dehumidification capacity (standard):	14 liters/day (30°C / 80% r.h.)
Min. air circulation:	98 m ³ /h
Max. Air circulation:	115 m ³ /h
Max. Noise emission:	30.5 dB (A)
Compressor:	Rotary compressor
Condensation tank:	Approx. 4.9 liters
Refrigerant:	R290 (65 g)
Cooling pressure (max.):	2.4 MPa
Vapor pressure (max.):	1.2 MPa
Maximum pressure heat exchanger:	2.6 MPa
Frequency band:	2.4 GHz (WLAN) with: < 20 dBm transmission power
Dimensions (H/W/D):	490 x 350 x 235 mm
Weight:	10.8 kg
Application range:	5°C ~ 32°C
Fuse:	T3. 15A 250 V
GWP:	3 (R290)

Troubleshooting:

The appliance does not dehumidify enough / Too little water collects in the condensation tank

Please remember that the primary aim is not to extract as much condensation water as possible, but to dry the room air or ceilings, walls and inventory and/or keep them dry!

Please also bear in mind that the dehumidifier can only remove moisture from the air and only indirectly from materials. Depending on the condition of the ceilings, walls and furnishings, it can take several weeks for them to release the stored moisture back into the air! For this reason, we also recommend that if you use your own humidity meter (hygrometer), you place it as freely as possible and at some distance from walls and ceilings, as otherwise the humidity value determined in the room air will be falsified!

As with all dehumidifiers, the dehumidification performance is decisively influenced by the following factors:

- A) Humidity content of the room air and
- B) Heat/Temperature in the room.

To be on the safe side, here is an excerpt from the dehumidification table at DAUERBETRIEB:

32 degrees and <u>80% r.h.</u> = approx. 15 liters	at <u>90% r.h.</u> = approx. 16 liters	at <u>60% r.h.</u> = approx. 8 liters
30 degrees and <u>80% r.h.</u> = approx. 14 liters	at <u>90% r.h.</u> = approx. 15 liters	at <u>60% r.h.</u> = approx. 7 liters
20 degrees and <u>80% r.h.</u> = approx. 7 liters	at <u>90% r.h.</u> = approx. 8 liters	at <u>60% r.h.</u> = approx. 5 liters
15 degrees and <u>80% r.h.</u> = approx. 6 liters	at <u>90% r.h.</u> = approx. 7 liters	at <u>60% r.h.</u> = approx. 4 liters
10 degrees and <u>80% r.h.</u> = approx. 5 liters	at <u>90% r.h.</u> = approx. 6 liters	at <u>60% r.h.</u> = approx. 3 liters
5 degrees and <u>80% r.h.</u> = approx. 3 liters	at <u>90% r.h.</u> = approx. 5 liters	at <u>60% r.h.</u> = approx. 2 liters

All figures are approximate per day (fluctuation tolerance) when measured directly at the appliance inlet and of course these values only apply if the temperature and humidity content remain constant!

Despite the hose connection, most of the water runs into the condensation tank

Check that the condensation hose has a gradient and is neither kinked nor blocked. Also check that the dehumidifier is standing level and that the castors are not necessarily in the joints on a tiled floor.

Other:

Warranty declaration:

Notwithstanding the statutory warranty claims, the manufacturer grants a warranty in accordance with the laws of your country, but at least 1 year (in Germany 2 years for private individuals). The warranty begins on the date of sale of the appliance to the end user.

The guarantee only covers defects that are attributable to material or manufacturing faults/defects.

Warranty repairs may only be carried out by an authorized customer service centre. To your warranty claim, the original sales receipt (with date of purchase) must be enclosed.

Excluded from the guarantee are:

- Normal wear and tear
- Improper use, e.g., overloading the appliance or non-approved accessories
- Damage due to external influences, use of force or foreign objects
- Damage caused by non-compliance with the operating instructions, e.g., connection to an incorrect mains voltage or non-compliance with the installation instructions
- Completely or partially dismantled appliances

Conformity:

The dehumidifier has been tested and itself and/or parts of it have been manufactured to the following (safety) standards:

“GS” tested by BUREAU VERITAS, and of course with CE conformity and EMC conformity.

Tested safety according to:	EN 60335-1:2012+A11:2014+A13:2017+A1:2019+A2:2019+A14:2019+A15:2021+A16:2023 EN 60335-2-40:2003+A11:2004+A12:2005+A1:2006+A2:2009+A13:2012 EN 62233:2008 AfPS GS 2019:01 PAK
CE (LVD) conformity tested according to:	EN 60335-1:2012+A11:2014+A13:2017+A1:2019+A2:2019+A14:2019+A15:2021+A16:2023 EN 60335-2-40:2003+A11:2004+A12:2005+A1:2006+A2:2009+A13:2012 EN 62233:2008
EMC conformity tested according to:	EN IEC 55014-1:2021 EN IEC 55014-2:2021 EN IEC 61000-3-2:2019+A1:2021 EN 61000-3-3:2013+A2:2021
RF conformity tested according to:	EN 301 489-1 V2.2.3 (2019-11) EN IEC 61000-3-2:2019+A1:2021 EN 61000-3-3:2013+A2:2021 EN 301489-17 V3.2.4 (2020-09) EN 300328 V2.2.2 (2019-07)
	➤ <i>Health and safety requirements pursuant to article 3 (1) a)</i> ➤ <i>Electromagnetic compatibility § 3(1)(2), Article 3(1)(b))</i> ➤ <i>Efficient use of the radio frequency spectrum Article 3(2)</i>

Correct disposal of this product:



Within the EU, this symbol indicates that this product must not be disposed of with household waste. Old appliances contain valuable recyclable materials that should be recycled. In addition, the environment and human health should not be harmed by uncontrolled waste disposal. Therefore, please dispose of old appliances via suitable collection systems or send the appliance to the place where you purchased it for disposal. They will then recycle the appliance.



We hope you enjoy using this device

Your Aktobis AG

Keep these instructions for use in a safe place !

Notes:
